

DOUBLE CHAINSTITCH

VC008

- 04

64 - 254

P / VSF

针数
Needle numbers

等距针距
Equal distance between needles

配件
Device

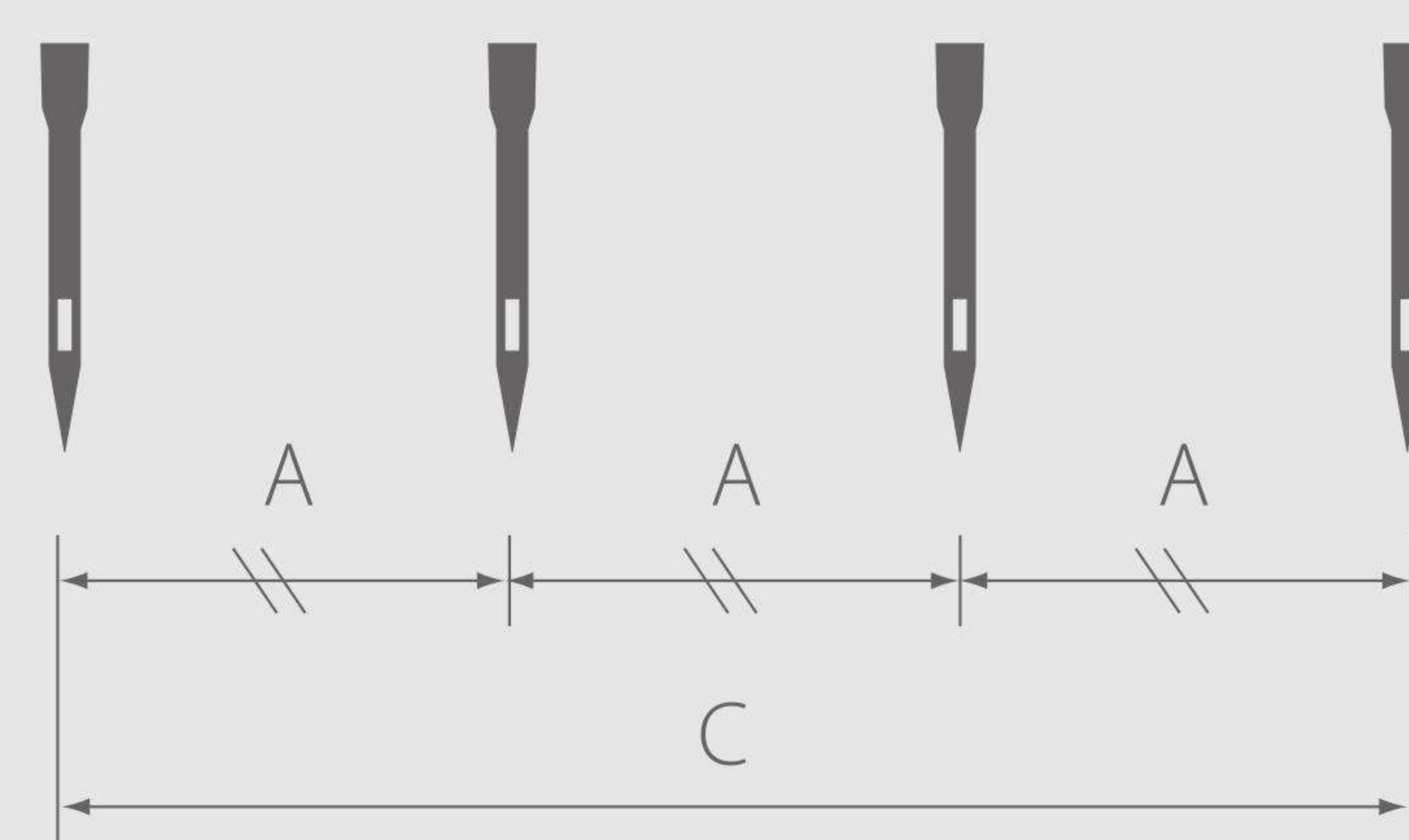

后拉引滚轮
Rear pullers

不等距
Unequal distance between needles

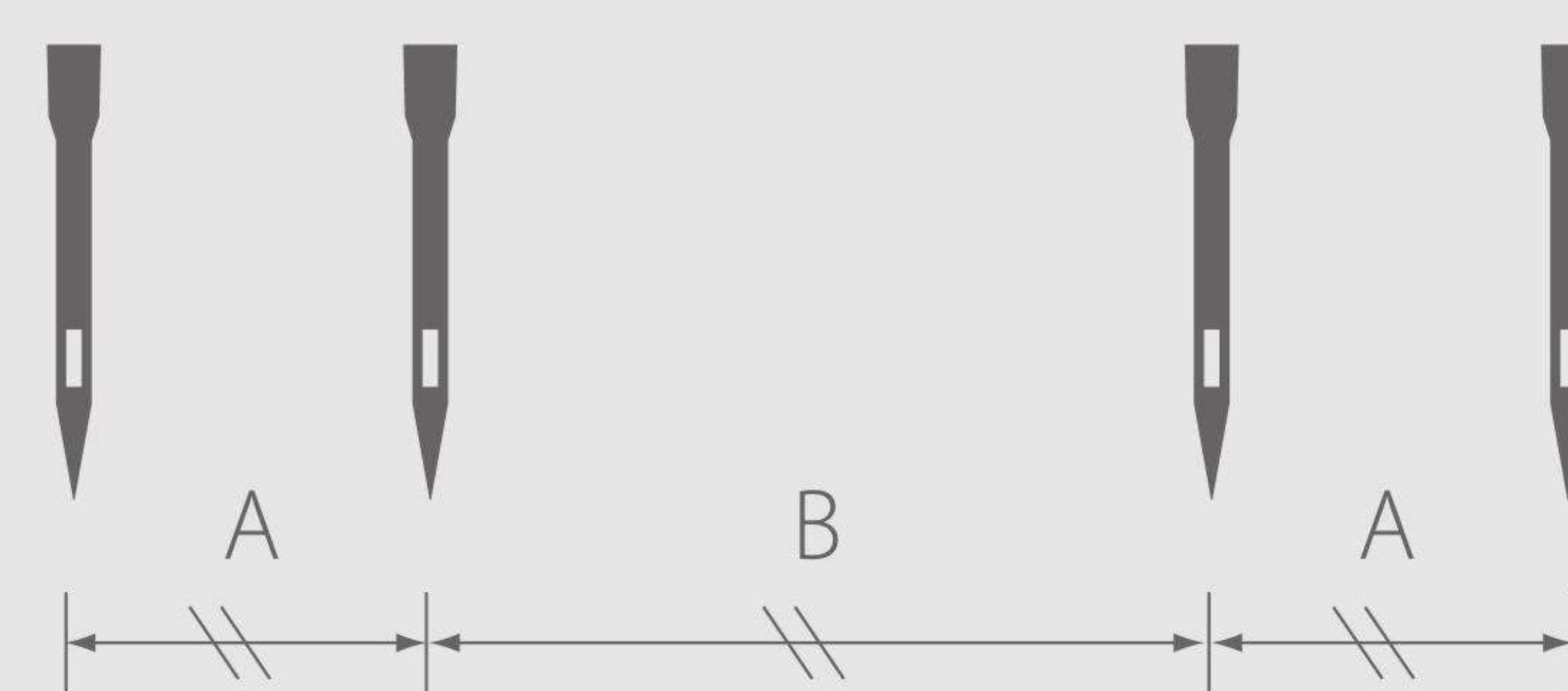

机种别 Model

VC008 多针机
Multineedle cylinder bed double chainstitch machine

HFO08 牛仔上腰机平车
Four needle flat bed double chainstitch machine

VC008 SERIES FEATURES

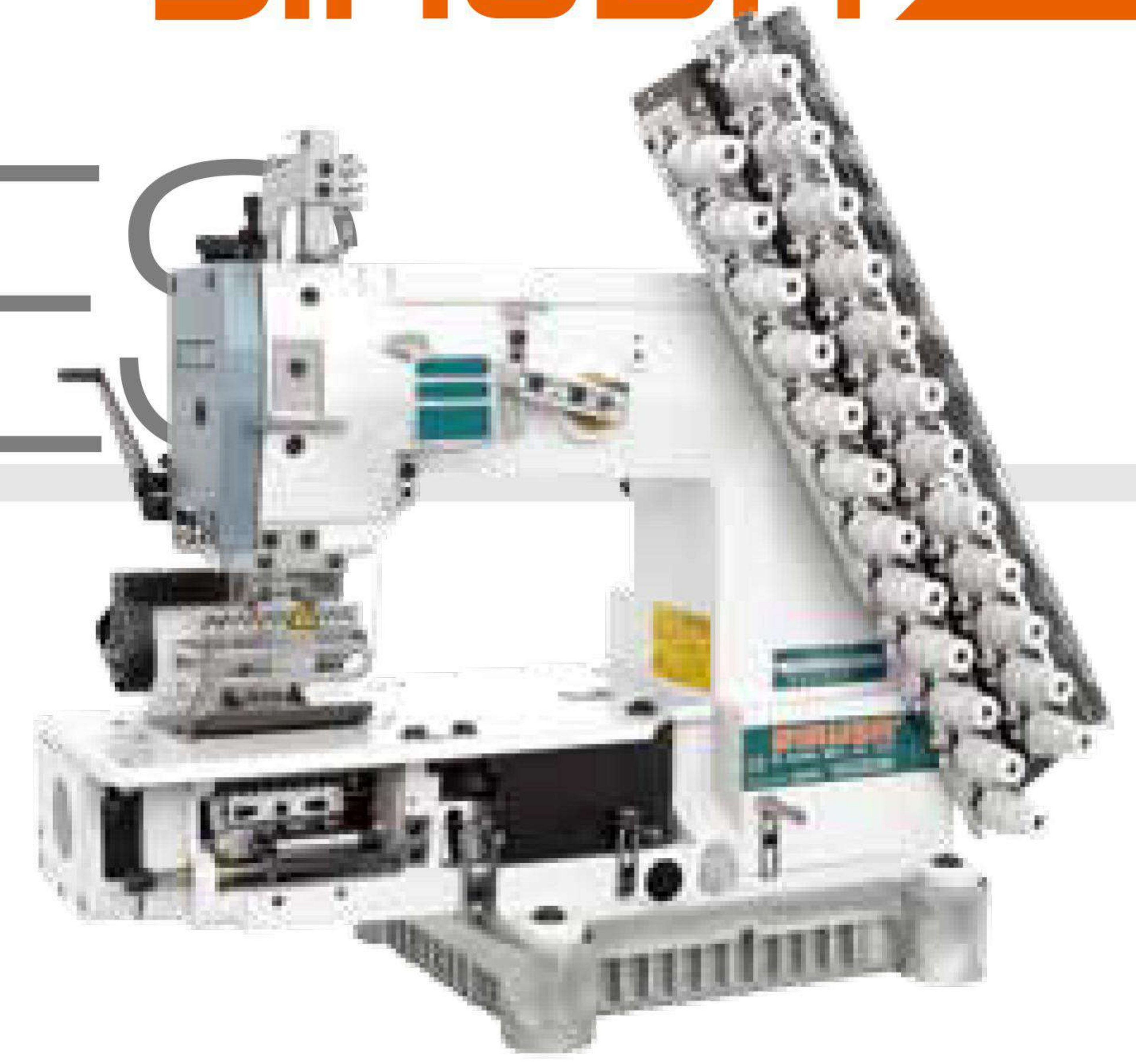

全自动供油，勾针纵向运动机构，多针双重链式缝

Automatic lubrication system, vertical looper mechanism, multineedle chainstitch mechanism.



采用独立勾针座，可变化不同的针位组合，达到一机多用的功能（选配）

Using independent looper holder and can easily change different needle position, Multi-function machine design.(optional)



筒型机身设计，方便环型衣物缝纫

Cylinder machine frame design, easy sewing operation for circular cloth.



按钮式缝距调整模式，调整简便快速

Stitch length adjustment by knob, easy and fast.





左侧附一辅助设计，拉布稳定，出布更顺畅，维护便利

Using one supportive puller on left side which can stabilize the pulling and sewing process.



适用于多种工序的缝纫，适合针织类高级衣物之装饰车缝

Suitable for multi sewing process, high quality knit material and decorative sewing.

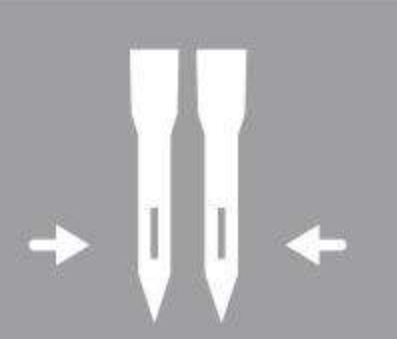
| Model | Specification |   |  | 图释 (每格宽度 =3.2mm=1/8") | | | | | | | | | | | | | | | | | | | | | | | | | | Remark | |
|-----------|---|---|---|---|---|----|---|---|---|---|---|---|----|----|----|----|----|----|----|----|----|----|----|----|----|----|----|----|----|--------|---|
| | | | | 1 | 2 | 3 | 4 | 5 | 6 | 7 | 8 | 9 | 10 | 11 | 12 | 13 | 14 | 15 | 16 | 17 | 18 | 19 | 20 | 21 | 22 | 23 | 24 | 25 | 26 | | |
| VC008- | 04064P | 4 | 8 | 1/4"(6.4mm) | | | | | | | | | | | | | | | | | | | | | | | | | | | |
| | 04085P | | | 1/3"(8.5mm) | | | | | | | | | | | | | | | | | | | | | | | | | | | |
| | 04095P | | | 3/8"(9.5mm) | | | | | | | | | | | | | | | | | | | | | | | | | | | |
| | 04106P | | | 5/12"(10.6mm) | | | | | | | | | | | | | | | | | | | | | | | | | | | |
| | 04127P | | | 1/2"(12.7mm) | | | | | | | | | | | | | | | | | | | | | | | | | | | |
| | 0448-191P | | | 3/16-3/4-3/16" (4.8-19.1-4.8mm) | | | | | | | | | | | | | | | | | | | | | | | | | | | |
| | 0448-222P | | | 3/16-7/8-3/16" (4.8-22.2-4.8mm) | | | | | | | | | | | | | | | | | | | | | | | | | | | |
| | 0448-254P | | | 3/16-1-3/16" (4.8-25.4-4.8mm) | | | | | | | | | | | | | | | | | | | | | | | | | | | |
| | 0464-191P | | | 1/4-3/4-1/4" (6.4-19.1-6.4mm) | | | | | | | | | | | | | | | | | | | | | | | | | | | |
| | 0464-127P | | | 1/4-1/2-1/4" (6.4-12.7-6.4mm) | | | | | | | | | | | | | | | | | | | | | | | | | | | |
| | 0464-254P | | | 1/4-1-1/4" (6.4-25.4-6.4mm) | | | | | | | | | | | | | | | | | | | | | | | | | | | |
| | 04A32-032P | | | (1/4-1/8-1/8-1/4")*3 (6.4-3.2-3.2-6.4mm)*3 | | | | | | | | | | | | | | | | | | | | | | | | | | | A |
| | 04A64P | | | 1/4"(6.4mm) | | | | | | | | | | | | | | | | | | | | | | | | | | | |
| | 12A32-032P | | | (1/4-1/8-1/8-1/4")*3 (6.4-3.2-3.2-6.4mm)*3 | 6 | 12 | | | | | | | | | | | | | | | | | | | | | | | | | B |
| 12A64P | 1/4"(6.4mm) | | | | | | | | | | | | | | | | | | | | | | | | | | | | | | |
| 12048P | 3/16"(4.8mm) | 12 | 24 | | | | | | | | | | | | | | | | | | | | | | | | | | | | |
| 12064P | 1/4"(6.4mm) | | | | | | | | | | | | | | | | | | | | | | | | | | | | | | |
| 12050P | 1/5"(5.0mm) | | | | | | | | | | | | | | | | | | | | | | | | | | | | | | |
| 13032P | 1/8"(3.2mm) | | | | | | | | | | | | | | | | | | | | | | | | | | | | | | |
| 13064P | 1/4"(6.4mm) | | | | | | | | | | | | | | | | | | | | | | | | | | | | | C | |
| 1332-032P | (1/4-1/8-1/8-1/4")*3 (6.4-3.2-3.2-6.4mm)*3 | | | | | | | | | | | | | | | | | | | | | | | | | | | | | | |
| 17032P | 1/8"(3.2mm) | | | | | | | | | | | | | | | | | | | | | | | | | | | | | D | |
| 21032P | 1/8"(3.2mm) | | | | | | | | | | | | | | | | | | | | | | | | | | | | | E | |
| 23032P | 1/8"(3.2mm) | | | | | | | | | | | | | | | | | | | | | | | | | | | | | F | |

A: 13 针规格组, 配 4 组针 / 勾针
B: 13 针规格组, 配 6 组针 / 勾针
C: 13 针规格组, 配 13 组针 / 勾针
D: 17 针规格组, 配 17 组针 / 勾针
E: 21 针规格组, 配 21 组针 / 勾针
F: 23 针规格组, 配 23 组针 / 勾针

A: 13-Needle gauge set with 4 sets of needle/ looper.
B: 13-Needle gauge set with 6 sets of needle/ looper.
C: 13-Needle gauge set with 13 sets of needle/ looper.
D: 17-Needle gauge set with 17 sets of needle/ looper.
E: 21-Needle gauge set with 21 sets of needle/ looper.
F: 23-Needle gauge set with 23 sets of needle/ looper.

| | | | | | | | |
|--|---------|--|----|------------|---------------------|--|------|
|  mm | 1.4-3.6 |  mm | 12 | Needle No. | UOX113GS #11~#14 |  S.P.M. (Max) | 4500 |
|--|---------|--|----|------------|---------------------|--|------|

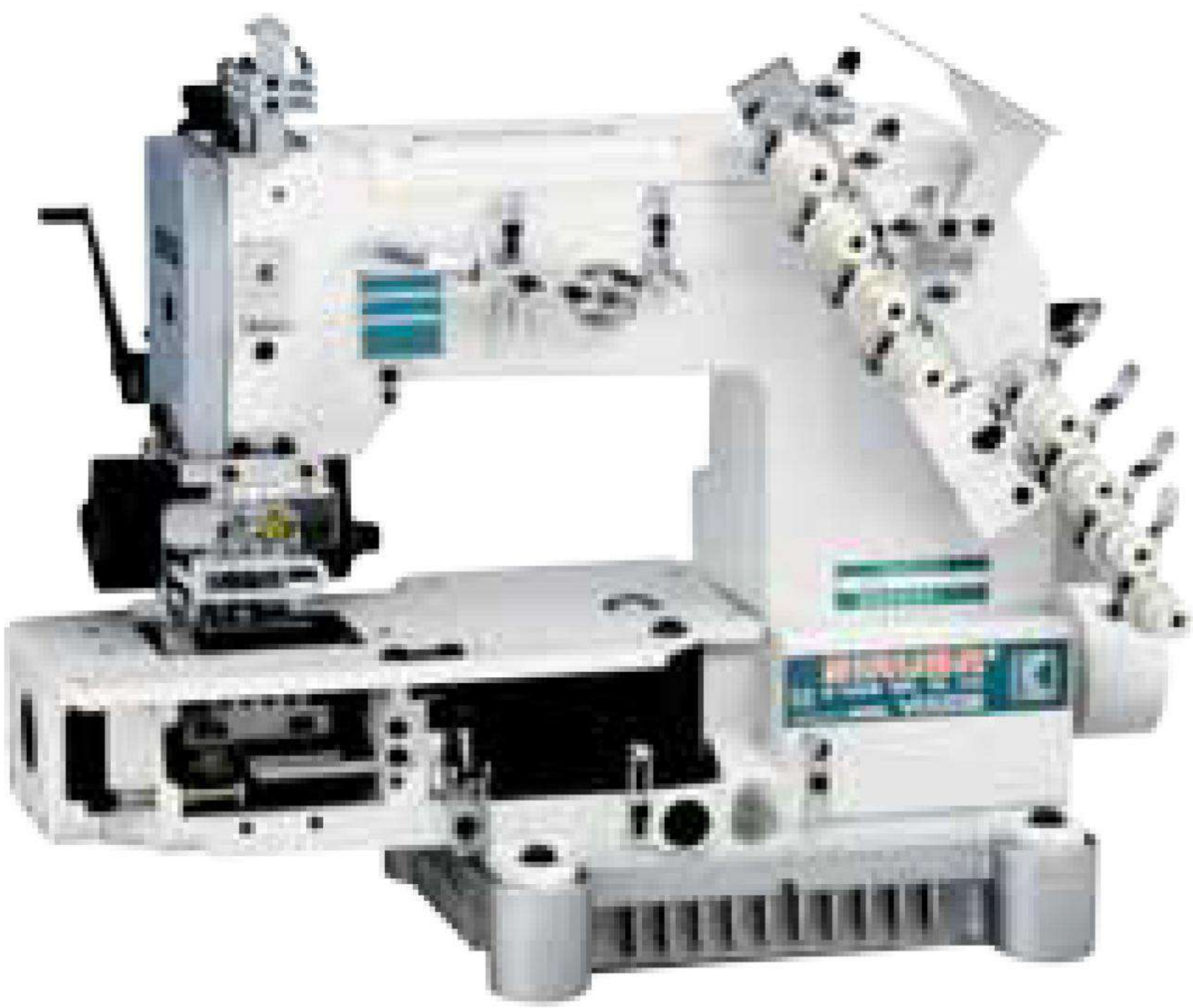

4針機型
4-Needle type
VC008-04XXX
VC008-04XXX-XXX



12針機型
12-Needle type
VC008-12XXX
VC008-12XXX-XXX
VC008-13XXX
VC008-13XXX-XXX
VC008-17XXX
VC008-21XXX
VC008-23XXX

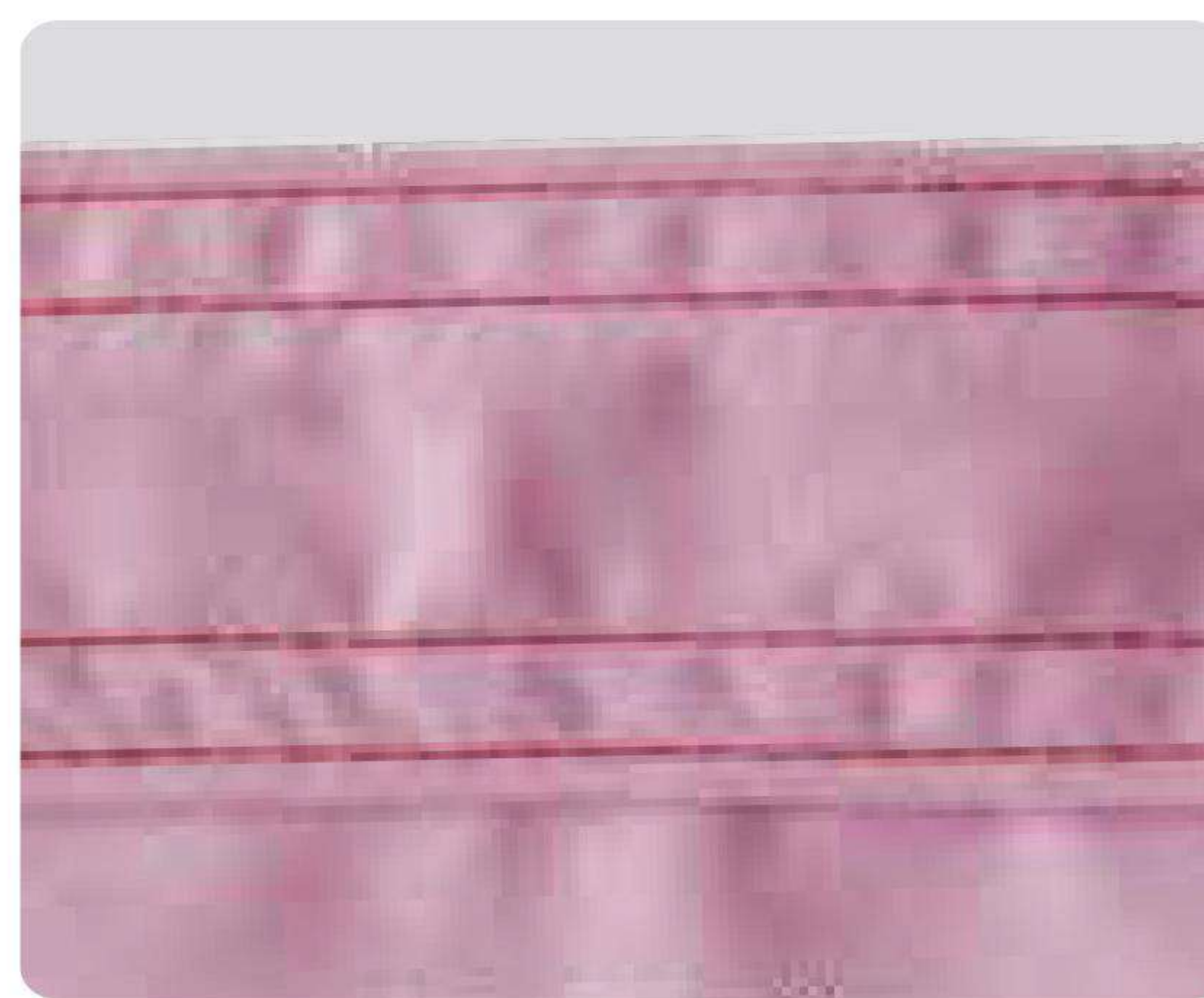
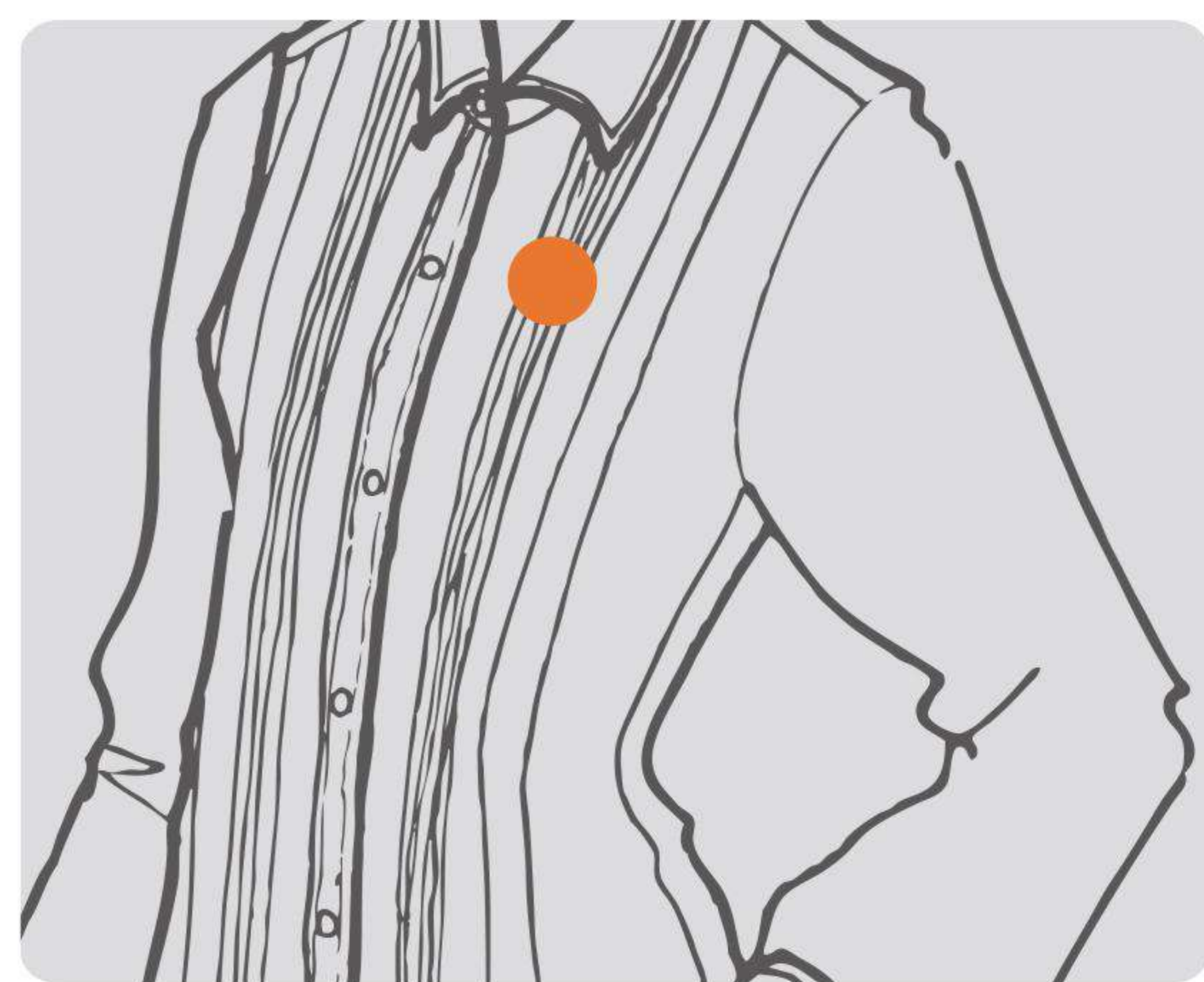





一般平縫

全自动给油，勾针纵向运动机构，筒型车台，利于圆筒型衣物之缝纫，适用于一般高级衣物之装饰车缝

GENERAL SEAMING

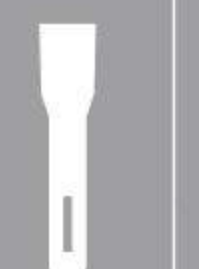
Cylinder bed automatic oiling, back and forth loopers driving mechanism, suitable for decorative sewing on high quality dress or tubular goods.

V2

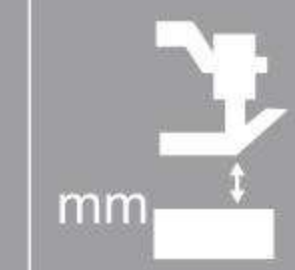
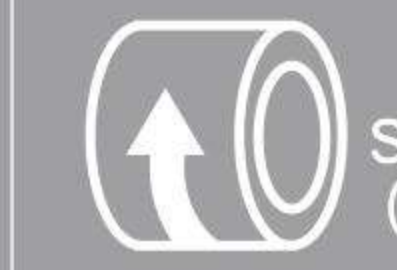
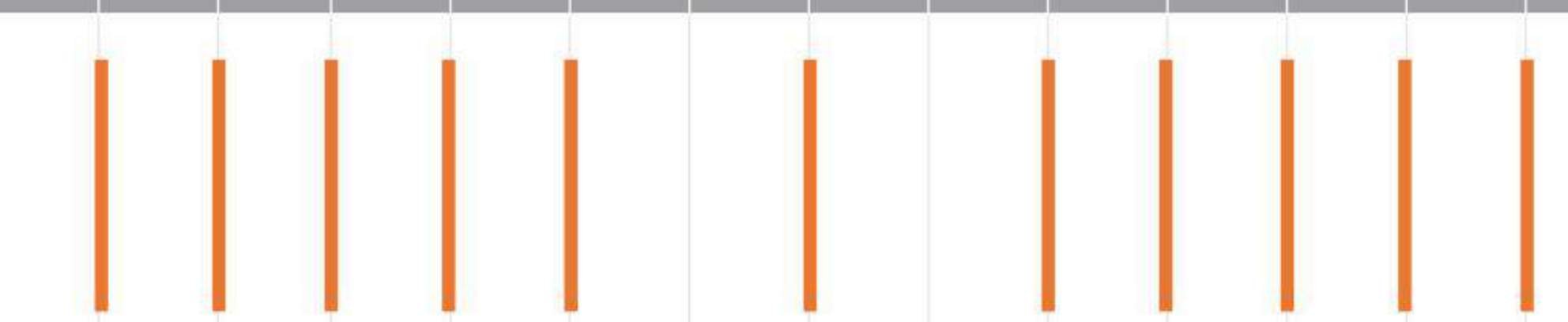
| Model | Specification |  |  |  |  mm | 2.5-5 |  mm | 12 | Needle No. | UOX113GS #11~#14 |  S.P.M. (Max) | 4500 | Remark | | | | | | | | | | | | | | |
|-----------------|---------------|---|---|---|--|-------|--|----|------------|---------------------|---|------|--------|--------------------------|---|---|---|---|---|---|---|---|----|----|----|----|----|
| | | | | | | | | | | | | | | 图释 (每格宽度 = 3.2mm = 1/8") | | | | | | | | | | | | | |
| | | | | | | | | | | | | | | 1 | 2 | 3 | 4 | 5 | 6 | 7 | 8 | 9 | 10 | 11 | 12 | 13 | 14 |
| VC008-1132-064P | | 11 | 22 | (1/8-1/4-1/8") (3.2-6.4-3.2mm) |  | | | | | | | | | | | | | | | | | | | | | | |

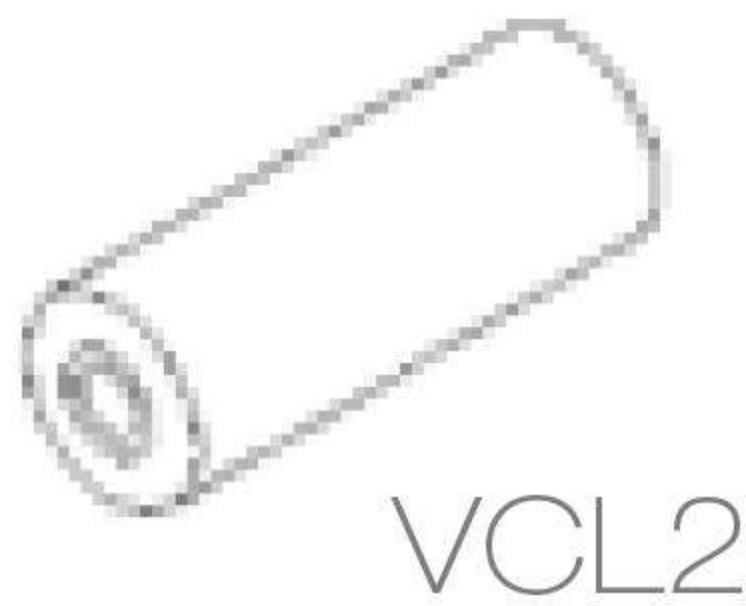
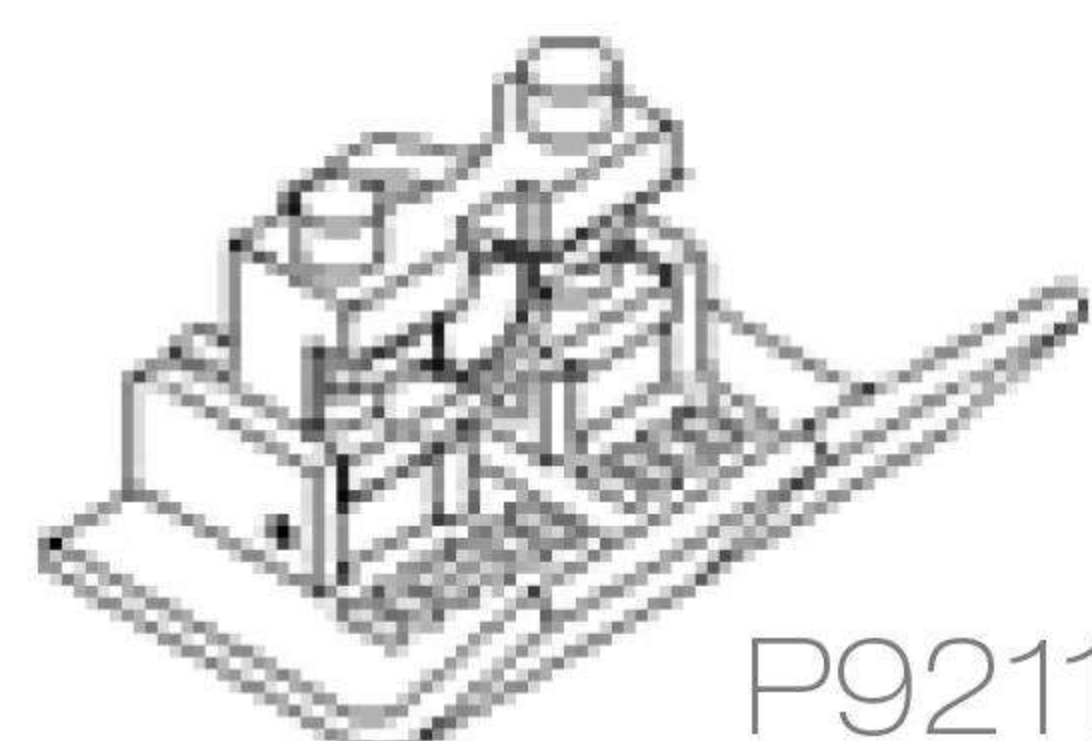

VC008-1132-064P

| | | |
|---|----------|--|
|  | VCL08S | 細齒上拉轮 (钢質), 薄牛仔 Fine teeth type upper puller (steel).light denim. |
|  | VCL16P | 平轮组 (PU 材質) Flat type puller set (PU) |
|  | VCL28 | |
|  | P9211A-A | 二段式押脚 Two-piece type presser foot |

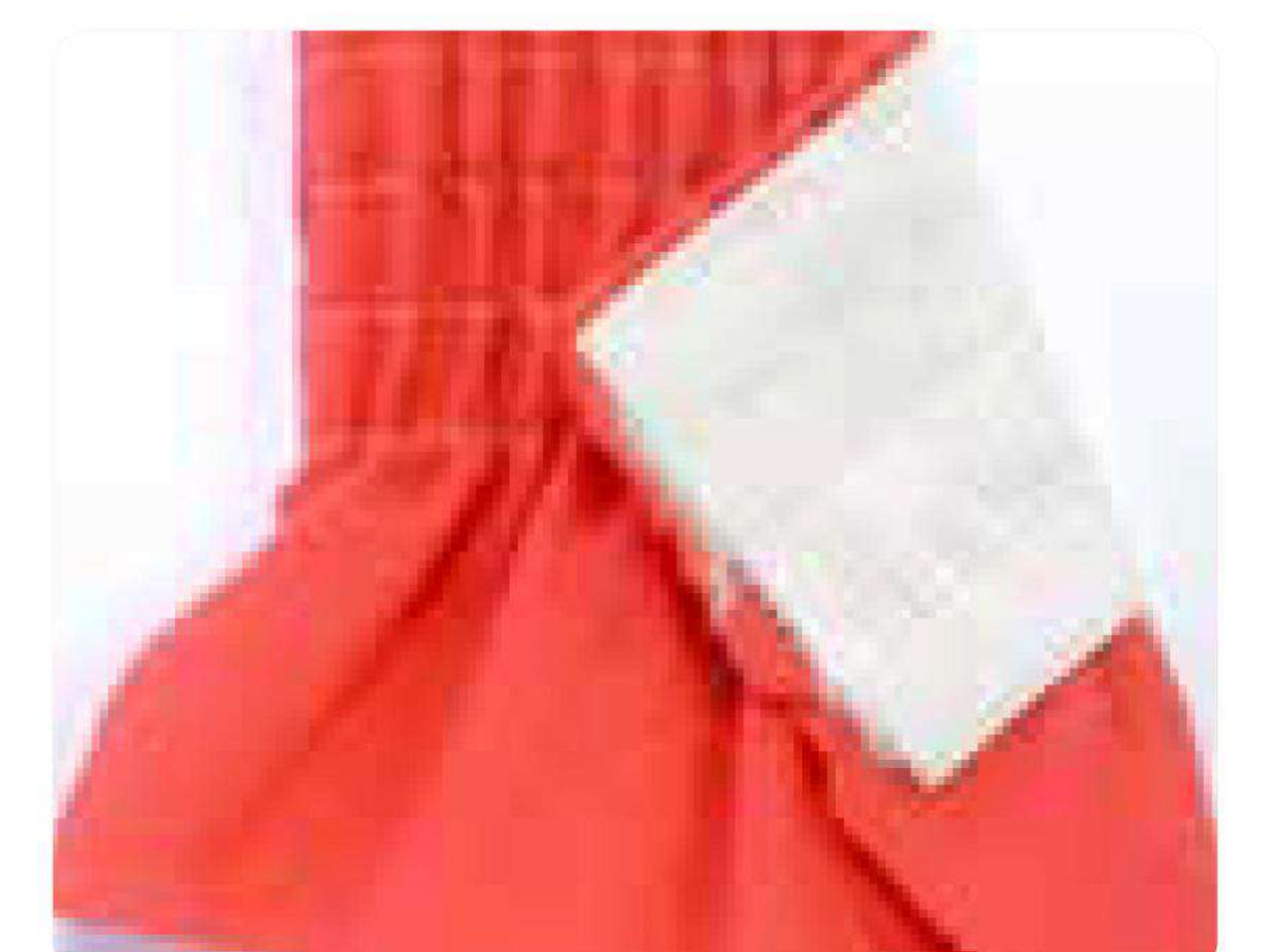
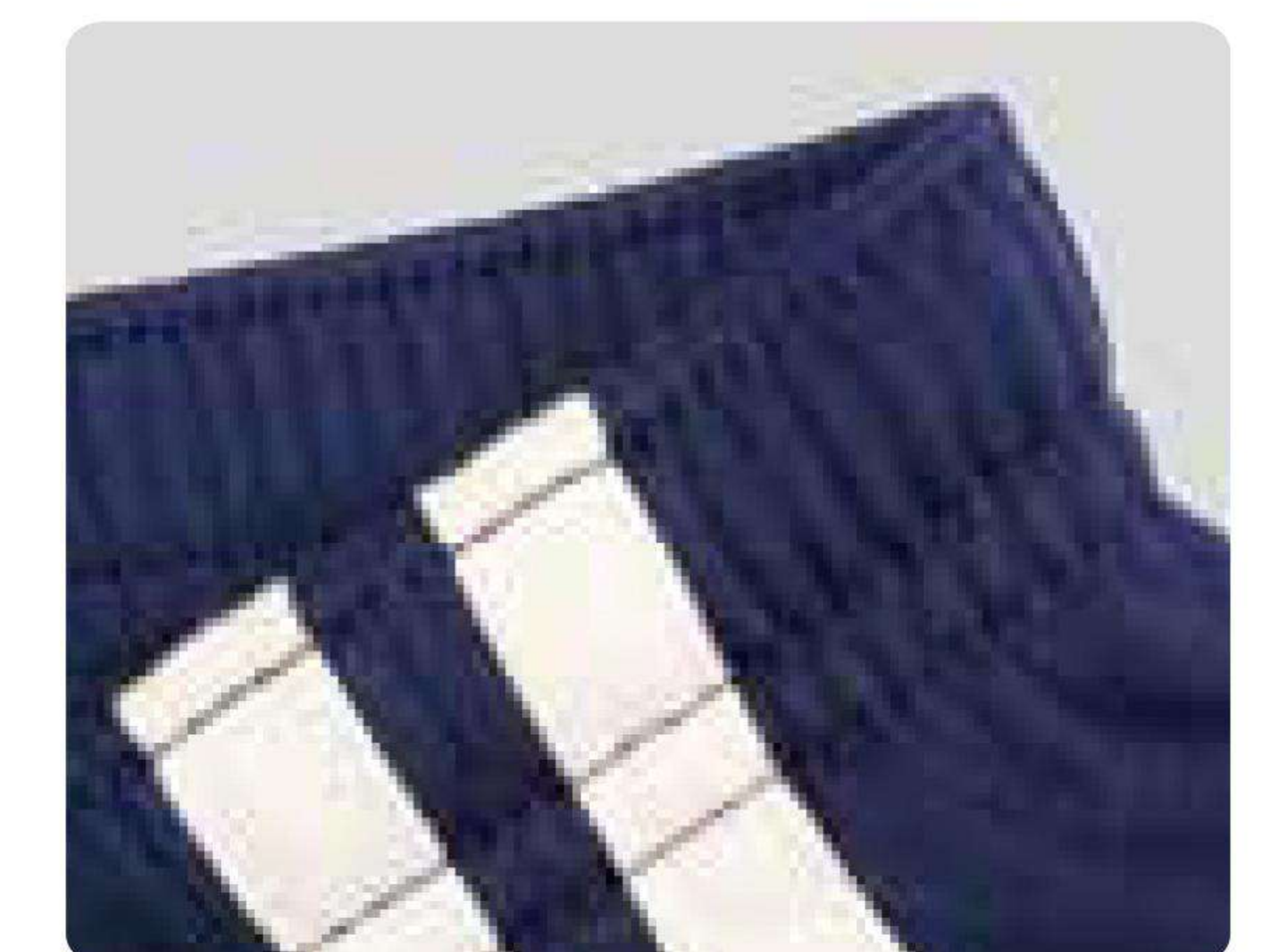

[三合一] 裤头车缝

本机型适用松紧带皱折型、平坦型、薄牛仔，可以弹性组合出各种常用的4针针位组如1/4-1/4-1/4, 1/4-3/4-1/4...等

[3 in 1] Waist band sewing

This model This model is applicable to elastic band winkled type, flat type, light denim, which offers various 4-needle gauges by one set. E.g.: 1/4-1/4-1/4, 1/4-3/4-1/4...etc.

| | |
|------|-----------------|
| 选购配件 | OPTIONAL DEVICE |
| | VCE |

DEVICE

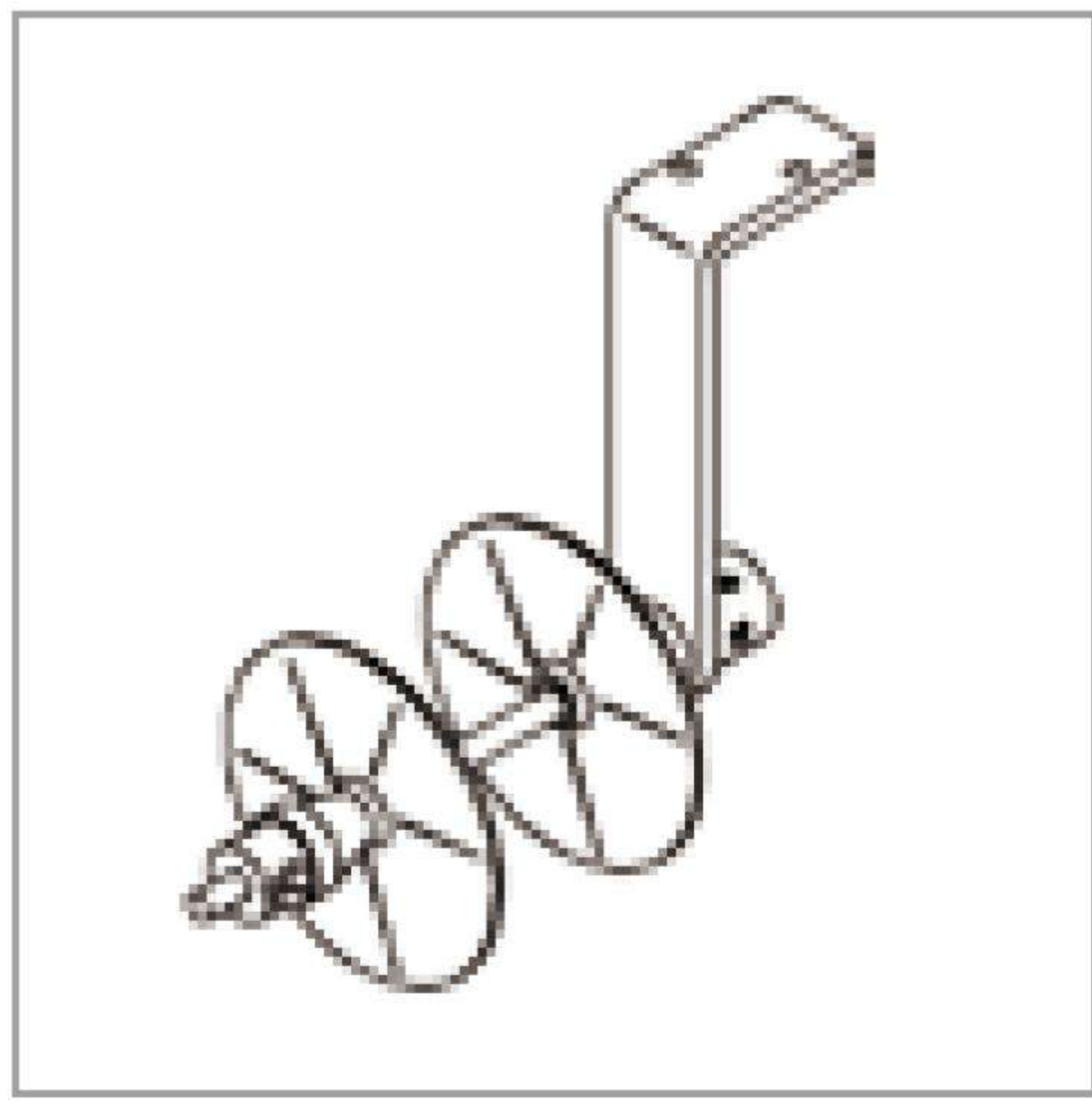

FH

下固定式送带盘 Lower Fixed Tape Holder

置于桌下方放布条或松紧带
Holds tape or elastic tape under the table

可自行组装 self-installation : YES
适用机型 applicable model : VC008/VWL, VC008/VWLB, VC008/VWLC, VC008/VSF
HF008/HPR



HWL(P)

后拉引滚轮 Rear Puller

协助车缝后平顺，不会挤压。与针位距离72mm，让拉布与出布更稳定
Smooths the sewing process, and no shirr. The 72 mm distance from the needle helps to stabilize the fabric during sewing process.

可自行组装 self-installation : NO
适用机型 applicable model : HF008



LSA

上固定式送带盘 Upper Fixed Tape Holder

置于上前方放布条或松紧带
Holds tape or elastic tape in front.

可自行组装 self-installation : YES
适用机型 applicable model : VC008/VPL, VC008/VSF



RL

筒型衣物撑开滚轮组 Tubular Extending Roller

协助将筒型衣物撑开,便于车缝
Extends the tubular material to make sewing process easier.

可自行组装 self-installation : YES
适用机型 applicable model : VC008/VCE



VAD

气压式抬押脚装置 Pneumatic Presser Foot Lifter

利用气压提升押具可提高效率
注: 1. 需有空压设备 2. 搭配伺服马达使用
Pneumatic presser foot lifter is used to improve operation efficiency.
Remark: 1. Compressor capability needed. 2. Servo motor needed.

可自行组装 self-installation : YES
适用机型 applicable model : VC008

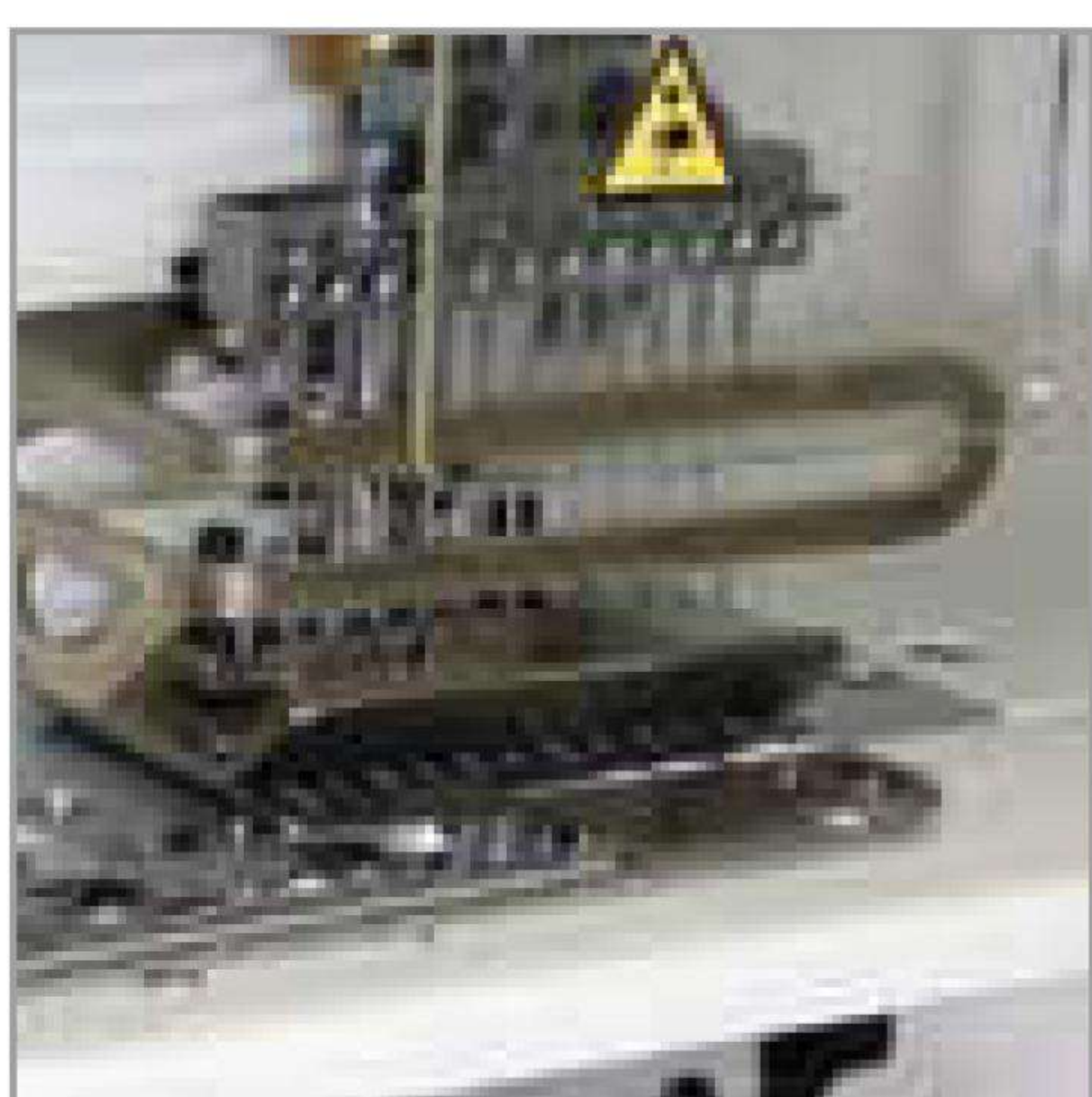

VCE

环型裤头松紧带上带装置 Tubular Elastic Inserting and Attaching

用于运动裤或男内裤等圆筒型衣裤上松紧带包缝，本机型可有两种缝合方式:

1. 环型松紧带布料折边缝
2. 拷克后上环形松紧带包缝

Tubular elastic inserting on sportswears or man's underwears, two types of sewing functions are available:

1. To attach tubular seamless elastic waistband.
2. To cover sewing on elastic after overlock seaming.

可自行组装 self-installation : YES
适用机型 applicable model : VC008



VCL(P) 后拉引滚轮 Rear Puller

协助车缝后平顺，不会挤压。与针位距离 72 mm, 让拉布与出布更稳定

注: 各机型搭配平轮或齿轮如下表, 若有异于标准品订购时请特别注明

Smooths the sewing process, and no shirr. The 72 mm distance from the needle helps to stabilize the fabric during sewing process.

Remark: Please check the type of pullers (flat or serrated) used for different machines from the table below. If you would like to order different pullers standard, please remark when ordering other than.

| 滚轮 / Roller | 平轮 / Flat | | 齿轮 / Gear | |
|--------------------|-----------|--------|-------------|-------------|
| 上 / Upper | VCL16 | VCL16P | VCL37(27T) | VCL37P(27T) |
| 下 / Lower | VCL28 | VCL28 | VCL33P(16T) | VCL33P(16T) |
| VC008-04xxxP | | | S | |
| VC008-04xxxP/VCE | | | S | |
| VC008-02xxxP/VMR | S | | | |
| VC008-04xxxP/VSF | S | | | |
| VC008-04xxxP/VWL | | | S | |
| VC008-06xxxP/VPL | | S | | |
| VC008-12xxxP | | | | S |
| VC008-12xxxP/VCE | | | | S |
| VC008-12xxxP/VPQ | | S | | |
| VC008-12xxxP/VPT | | S | | |
| VC008-12xxxP/VWL | | | | S |
| VC008-12xxxP/VPQ-K | | S | | |
| VC008-12xxxP/VSM | | VCL16D | | |
| VC008-12xxxP/VSQ | | VCL16D | | |

VCL 滚轮明细表 VCL Roller List

| Type | 平轮 Flat Type | | | | 齿轮 Gear Type | | 压花 Knurling | |
|-------------------|-----------------|------------------------|---------------------|--------|-----------------------|---------------------|--------------|--------------|
| 材质 Material | 硬质塑料 PU (White) | | 软质橡胶 Rubber (Black) | | 塑钢 POM (White) | | 钢质 Steel | |
| 长度 Length | 56mm | 80mm | 56mm | 80mm | 56mm | 80mm | 56mm | 78mm |
| 上滚轮护盖 Upper Cover | VCL39Q | VCL39R | VCL39Q | VCL39R | VCL39Q | VCL39R | VCL39Q | VCL39R |
| 上滚轮 Upper | VCL16 | VCL16P | VCL16Q | VCL16R | VCL08(22T) 厚 Heavy | VCL08P(22T) 厚 Heavy | VCL08Q (59T) | VCL08N (22T) |
| | | VCL37(27T) 中厚 Medium | | | VCL37P(27T) 中厚 Medium | | | |
| | | *VCL16D (for VSM, VSQ) | | | VCL59(44T) 薄 Light | VCL60(44T) 薄 Light | | |
| | | VCL62(54T) 轻薄 Fine | | | VCL63(54T) 轻薄 Fine | | | |
| 下滚轮 Lower | VCL28 | VCL28R | VCL28R | VCL28R | VCL33(14T) 厚 Heavy | VCN33N(22T) | VCN33N(22T) | VCN33N(22T) |
| | | | | | VCL33P(16T) 中厚 Medium | | | |
| | | | | | VCL61(28T) 薄 Light | | | |
| | | | | | VCL64(32T) 轻薄 Fine | | | |

滚轮选用原则 Puller Set Application

| | | |
|-----------------------------|---------------------|--|
| 平轮 Flat type | 塑料 PU | 适用一般薄布料，如梭织棉布 For common materials, eg: woven cotton fabric. |
| | 橡胶 Rubber | 适用贴带车缝, 或光滑薄布料使用，如梭织丝光布 For tap attaching or slippery materials, eg: woven silk fabric. |
| 齿轮 Gear type | 粗齿塑钢 Big-teeth POM | 适用松紧带车缝, 大折景 For elastic band sewing, big gathering |
| | 细齿塑钢 Fine-teeth POM | 适用松紧带车缝, 小折景 For elastic band sewing, small gathering |
| 钢质压花轮 Knurling Steel roller | | 适用牛仔类与厚布料 For jeans and heavy material |

可自行组装 self-installation : NO

适用机型 applicable model : VC008



VMR

双针打折装置 Ruffling

适用于窗帘，床罩等寝具的装饰缝及桌布或室内装饰品之打折，由花盘(凸轮)控制可缝制各种各样漂亮的皱折

注:1.皱折最大间距 7-8 mm

2.六块花盘凸轮如V15附图

Decorative sewing on curtain and bed sheets or various ruffling patterns on table cloth or indoor decoration which controlled by cams.

Remark: 1. Maximum 7-8 mm space for shirring.

2. Six cams as listed on V15.

可自行组装 self-installation : NO

适用机型 applicable model : VC008-02064P



VPL

贴带装置 Tape Attaching

主要用于衬衫门襟，腰带，运动衣等装饰条带

注: 1.喇叭成品规格如图表

2.布条之尺寸可依3/16"或1/4"倍数变换

Decorative tape for shirt-fronting, sportswears, waist band, etc...

Remark: 1. Folder and finished goods specifications as listed in the table below

2. Tape size can be adjusted in multiples of 3/16" or 1/4".

| 机型 Model | 完成尺寸 Finished Size(mm) | X | Y | Z | 针距 Needle Gauge | 押具 Presser Foot |
|--------------|------------------------------|-------|--------|-------|--------------------|--------------------|
| VC008-06048P | 8 | B417P | B417AP | B417P | 3/16" | P9412DA |
| | 9 | B417Q | B417AQ | B417Q | | P9412D |
| VC008-06064P | 10 | B417R | B417AR | B417R | 1/4" | P9512DA |
| | 12 | B417S | B417AS | B417S | | P9512D |
| | 16 | B417U | B417AU | B417U | 1/2" | P9512B |
| VC008-12064P | 16 | B417U | B417AU | B417U | 1/4" | P9712D |

可自行组装 self-installation : YES

适用机型 applicable model : VC008-06048P, VC008-06064P



VPQ

COMPUTER-EXPORT

适用于女用裙皱折，连身衣裙等腰边松紧带皱折均能顺畅缝纫，勾针底线宜用弹性线
Suitable for sewing ornamental shirring on women's blouses. Suggested to use elastic thread for lower looper.

可自行组装 self-installation : YES

适用机型 applicable model : VC008-12048P, VC008-12064P



VPQ-K

弹性线抽折缝装置 Elastic Thread Shirring

适用于女用裙皱折，连身衣裙等腰边松紧带皱折均能顺畅缝纫

1.勾针底线宜用弹性线

2.增加VWL组可稳定松紧带的松紧度让车缝更平顺美观,不跳针

3.将弹性线安装于桌板下，让弹性线车缝更顺畅

4.本配件为多功能,可调为VWL，VPQ单一使用

Suitable for sewing ornamental shirring on women's blouses.

1. Suggested to use elastic thread for lower looper.
2. The added VWL set will further stabilize the tension of elastic thread and make sewing process more smoothly, also can avoid stitch skipping.
3. Holds the elastic thread under the table to make sewing process more smoothly.
4. Multifunction device can be adjusted to VWL or VPQ.

可自行组装 self-installation : YES

适用机型 applicable model : VC008-12048P, VC008-12064P



VPS

弹性线抽折缝装置 Elastic Thread Shirring

适用于女用裙皱折，连身衣裙等腰边松紧带皱折，如：女衬衫，游泳衣，妇女用衣物，枕头套，儿童衫。针线用弹性线，勾针为勾线功能不穿线，为101车缝式样

Suitable for sewing ornamental shirring on women's blouses, swimsuits, pillowcases, children's shirts. Needle uses elastic thread and looper without any thread. It's 101 sewing type.

可自行组装 self-installation : YES

适用机型 applicable model : VC008-12048P, VC008-12064P



VPT

折布车缝装置(明折缝) Tucking (Visible Fold Seaming)(VPT) 折布车缝装置(暗折缝) Tucking (Blind Fold Seaming) (VPTA)

配合多种导边器可组合各种打折，右倾或左倾折均能完美之缝纫如：衬衫、连衣裙、衣服、儿童衬衫、尼龙裤等细条打折用

注：如购一般机型自行安装的VPT时，VA05及VA06导边器固定处需自行攻牙

Using various folders for different side shirring patterns, suitable for shirts, women's dress, children's shirts, nylon pants.

REMARK: When installing VPT device on standard machine, position of VA05 and VA06 folder need to be tapped first.

可自行组装 self-installation : YES

适用机型 applicable model : VC008-12048P, VC008-12064P



VWL VWLB VWLC

前松紧带送带滚轮装置 Front Elastic Feeding

松紧带送带滚轮装置能随机台本身之运转，将松紧带送出，且可调整松紧带送出量之多寡，操作简便；车缝慢跑裤，运动裤，休闲裤等裤头，由于前后导轮装置，上松紧带时能保持一定张力，维持车缝品质

註：VWL附B413喇叭

VWLB附B411喇叭及撑开滚轮组

VWLC附VCE导片

Length of elastic type can be easily adjusted by elastic feeding device, suitable for sports pants and casual pants. Roller maintains the tension of elastic thread and quality during sewing process.

REMARK: VWL with folder B413

VWLB with folder B411 and extending roller

VWLC with VCE fabric guide

可自行组装 self-installation : YES

适用机型 applicable model : VC008-04064P, VC008-04085P, VC008-04095P,
VC008-04106P, VC008-04127P, VC008-12048P,
VC008-12064P

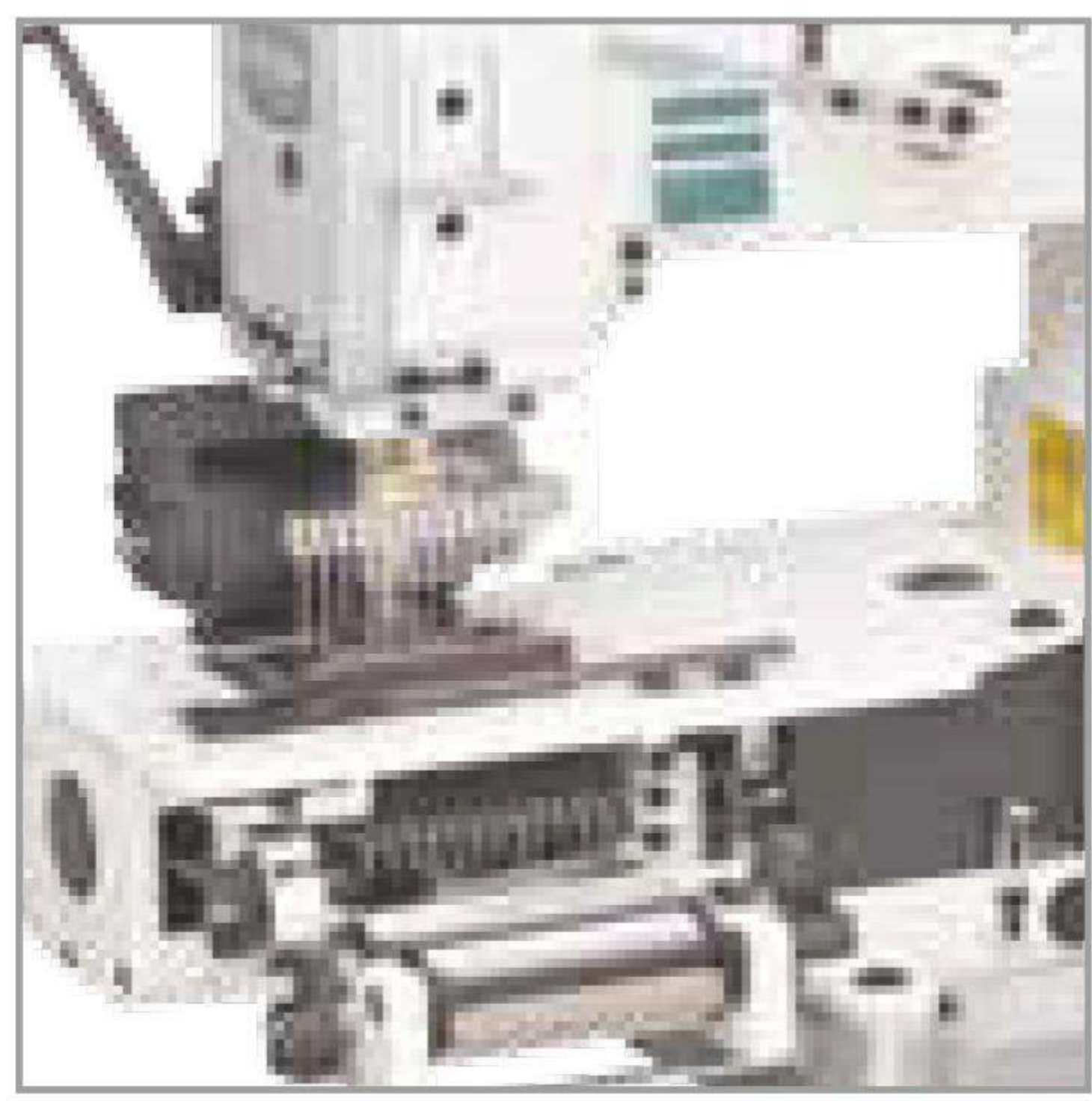

VSC

松紧带抽皱缝装置 Elastic Thread Shirring Sewing

弹性线直送不打线圈，由针线与勾针线上下包覆，车缝成品效果较VPQ薄，且皱折可拉伸至完全平坦

Elastic thread is straight, not looped, which is fixed by needle thread and looper thread. The finish is thinner than VPQ and the shirring becomes flat as it is pulled extensively.

可自行组装 self-installation : NO

适用机型 applicable model : VC008-12048P, VC008-12064P



VSF

门襟车缝装置 Shirt-Fronting

对于各种衬衫门襟用四针或二针,因有专用滚边器配合使用,只要一道工序即可完成. 连续缝纫非常顺畅.喇叭尺寸如图表

Using 4 or 2 needle and special folder for shirt-fronting, only one sewing process is required. Size of folder as listed in the table below.

| 规格Spec 代号Code | 完成尺寸 Finished Size | 人布宽度 Tape Size | 针距 Needle Gauge | 机型 Model |
|------------------|-----------------------|-------------------|--------------------|-----------------|
| B529 | 1-3/8" | 2-3/8" | 1/4 - 3/4 - 1/4" | VC008-0464-191P |
| B529P | 1-1/2" | 2-1/2" | 3/16 - 1 - 3/16" | VC008-0448-254P |
| B529Q | 1-5/8" | 2-5/8" | 1/4 - 1 - 1/4" | VC008-0464-254P |

可自行组装 self-installation : YES

适用机型 applicable model : VC008-0448-254P, VC008-0464-191P,
VC008-0464-254P

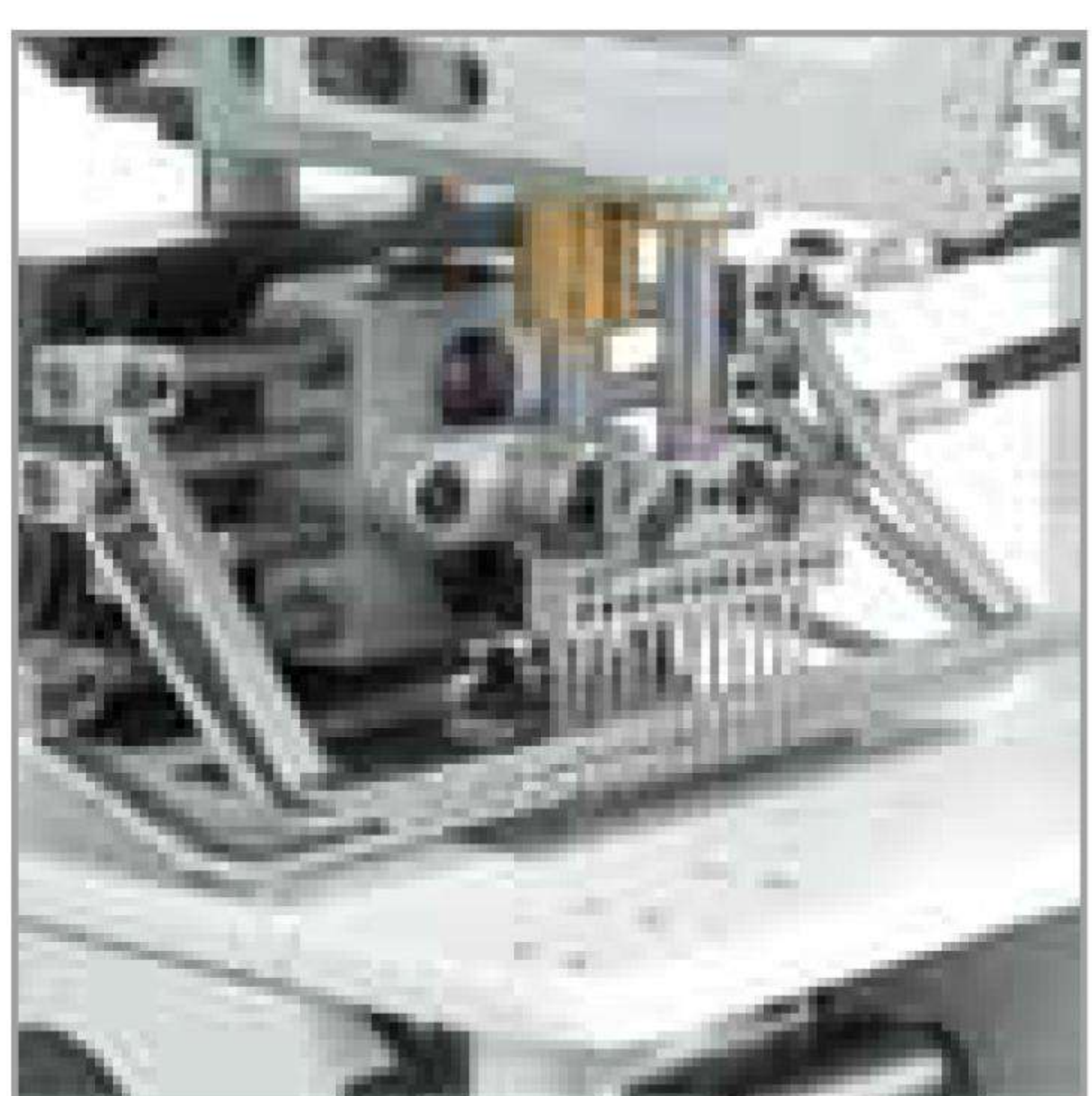

VSM

花饰缝装置 Decorative Sewing

由16个花盘变化，利用针线之搭配，可缝制数十种不同花样，适用于高级衣饰、窗帘、床罩等寝具的装饰缝及桌巾或室内装饰品之花饰缝

To use sixteen different cams of variation for different sewing, suitable for decorative sewing on high quality dresses, curtains, bed sheets and tablecloths.

可自行组装 self-installation : NO

适用机型 applicable model : VC008-12048P, VC008-12064P



VSSM

花饰缝 Decorative Sewing

由16个花盘变化，利用针线之搭配，可缝製数十种不同花样，适用于高级衣饰、窗帘、床罩等寝具的装饰缝及桌巾或室内装饰品之花饰缝

To use sixteen different cams of variation for different sewing, suitable for decorative sewing on high quality dresses, curtains, bed sheets and tablecloths.

可自行组装 self-installation : NO

适用机型 applicable model : VC008-12048P, VC008-12064P

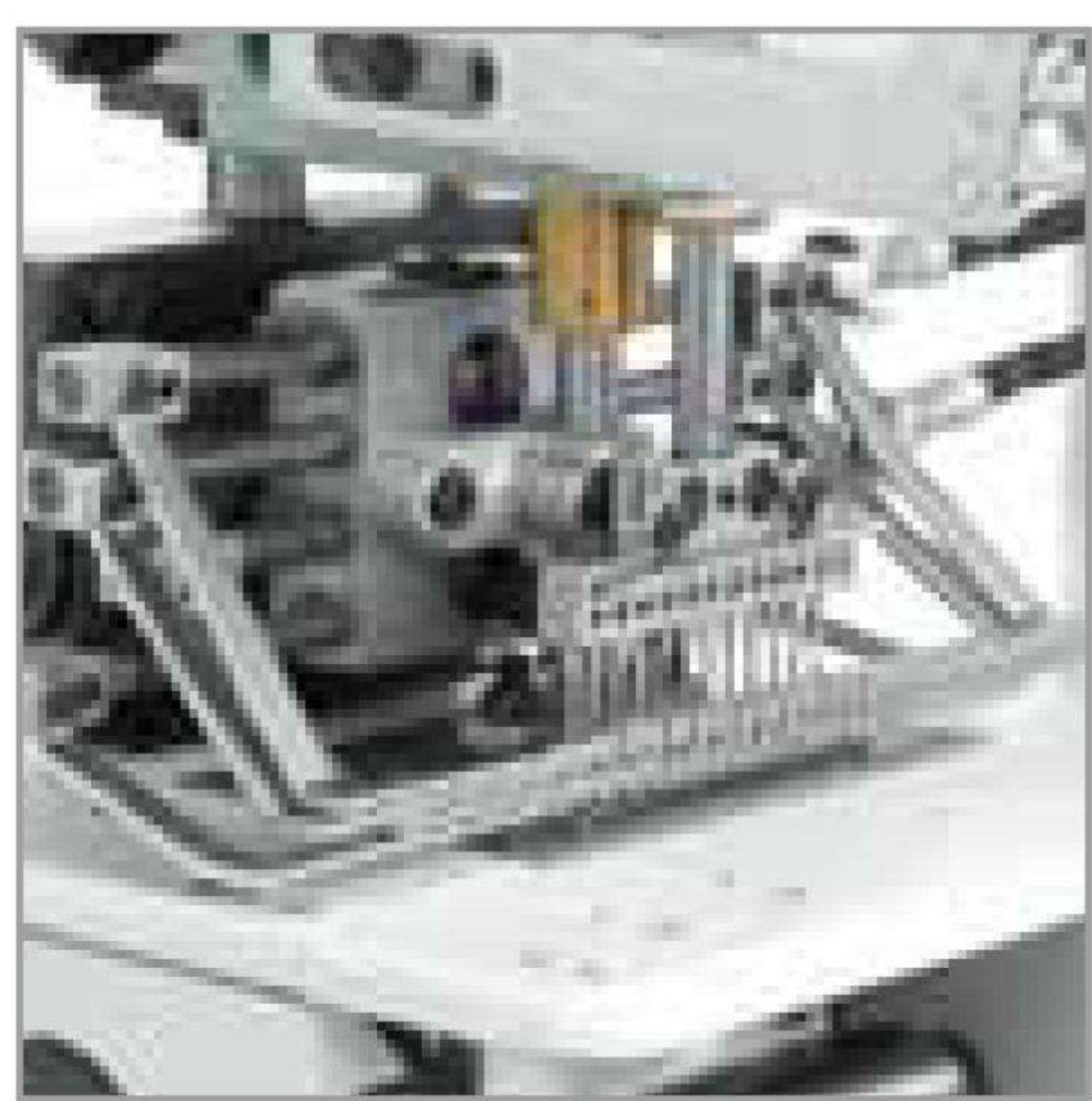

VSQ

松紧花饰缝装置 Decorative Sewing with Elastic Thread Shirring

由16个花盘变化，利用针线之搭配,可缝制数十种不同花样，适用于高级衣饰、窗帘、床罩等寝具的装饰缝及桌巾或室内装饰品之花饰缝

To use sixteen different cams of variation for different sewing, suitable for decorative sewing on high quality dresses, curtains, bed sheets and tablecloths.

可自行组装 self-installation : YES

适用机型 applicable model : VC008-12048P, VC008-12064P

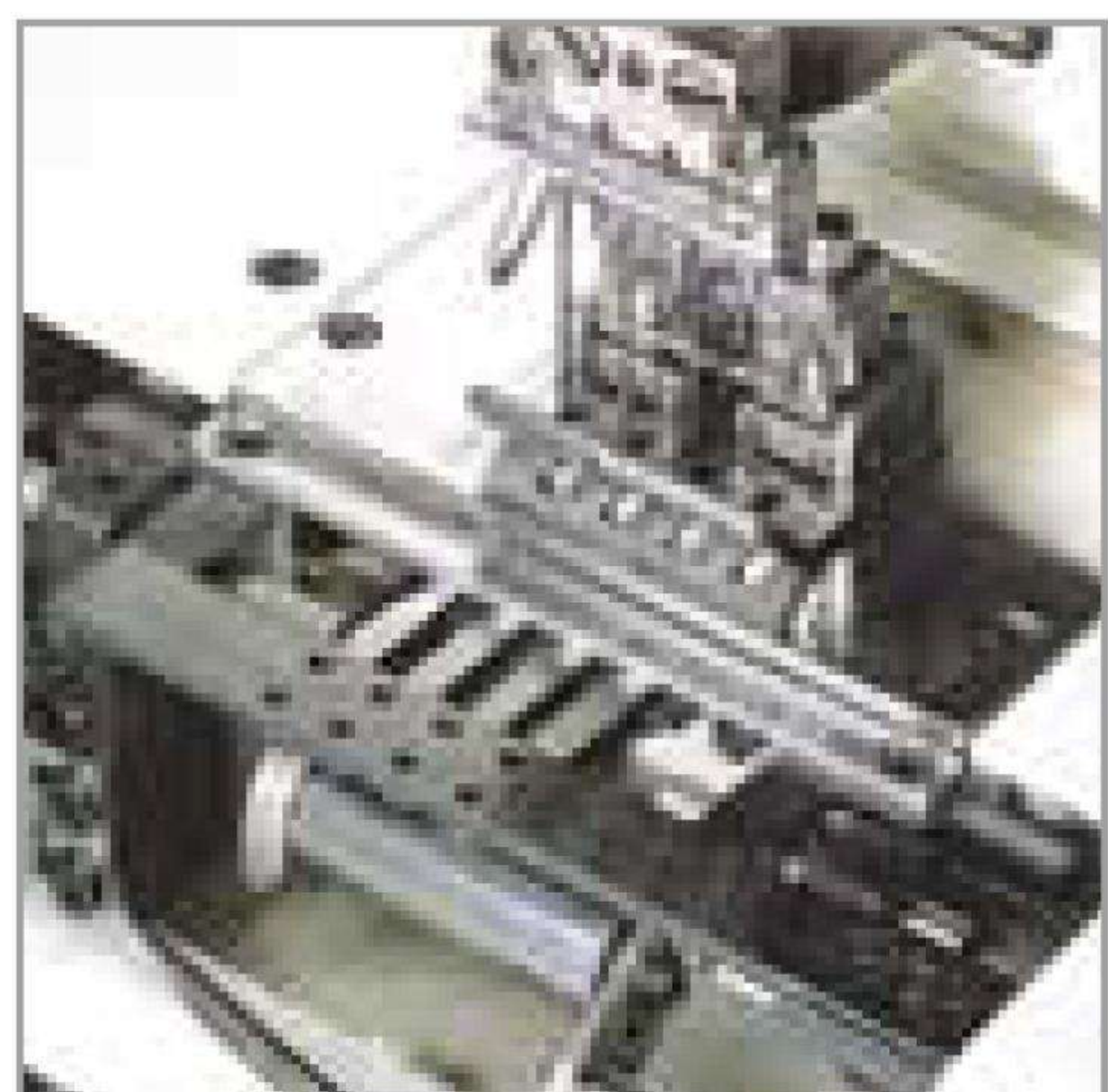

VUT

自动切线装置 Pneumatic Automatic Thread Trimmer

气动式自动切线可提高车缝效率节省成本

Pneumatic automatic thread trimmer increases operation efficiency and saves the cost.

可自行组装 self-installation : NO

适用机型 applicable model : VC008-04064P, VC008-04085P, VC008-04095P
VC008-04106P, VC008-04127P, VC008-12050P

VC008 弹性线机型对照/ VC008 Comparison on Elastic Thread Models

| 型号 Model | 布样 Sample Fabric | 面线(针线) Surface Thread (Needle Thread) | 底线(勾针线) Rear Thread (Looper Thread) | 花样线 Decorative Thread | 备注 Remark |
|-------------|---------------------|---|---|-----------------------------|--|
| VPQ | | 一般 Standard | 弹性线 Elastic | - | |
| VPQK | | 一般 Standard | 弹性线 Elastic | - | 车缝与VPQ完全相同 差别在多加VWL下送轮, 使底线控线稳定 Same stitch as VPQ. The difference is on the front roller, VWL, which stabilizes rear thread controls. |
| VPS | | 弹性线 Elastic | 无 None | - | 勾针不穿线 Looper without thread. |
| VSM | | 一般 Standard | 一般 Standard | V | 可平,也可皱折 Flat or shirring at options |
| VSQ | | 弹性线 Elastic | 无 None | V | 功能=VPS+VSM 弹性线抽皱折 Function equates VPS plus VSM. Elastic shirring. |
| VSC | | 一般 Standard | 一般 Standard | - | 弹性线拉直,由底线与面线包 Elastic thread is stretched and covered by rear thread and surface thread. |
| VSSM | | 一般 Standard | 弹性线 Elastic | V | 功能=VSM+VPQ Function equates VSM plus VPQ. |

MOTOR

| 代码 Motor No. | | 规格 Specification | | | | | 适用机型 Applicable Model |
|----------------------------------|--------------------|------------------|---------|------|-------|--------------------------------------|--------------------------|
| | | W | V | Pole | Phase | HZ / R.P.M. | |
| 离合器马达 Clutch Motor | T3230Dx | 400W | 110 | 2 | 1 | 50HZ/2850 R.P.M. 60HZ/3450 R.P.M. | VC008 HF008 Z008 |
| | T3201Dx | | 220 | | | | |
| | T3202Dx | | 240 | | | | |
| | T3203Dx | | 380 | | | | |
| | T3204Dx | | 220 | | | | |
| | T3231Dx | 550W | 110 | | 1 | | |
| | T3205Dx | | 220 | | | | |
| | T3206Dx | | 240 | | | | |
| | T3207Dx | | 380 | | | | |
| | T3208Dx | | 220 | | | | |
| 伺服马达 Servo Motor | T6424EH T6425EH | 750W | 220-240 | 4 | 1 | 50HZ/60HZ 3500 R.P.M. | VC008 VC008/VUT |
| | T7119CH | 550W | 380 | | 3 | 50HZ/60HZ 3000 R.P.M. | HF008 Z008 |
| | TC201KH TC202KH | | 220-240 | | 1 | | |
| | TC301EH | | 380 | | 3 | | |
| | | | 220-240 | | | | |
| 简易伺服马达 Simplified Servo Motor | TSA-750 | 750W | 220-240 | 4 | 1 | 50HZ/60HZ 5000 R.P.M. | VC008 |

TABLE

| 桌板代号 Item No. | 尺寸 / Size(Mm) | | | 说明 Description | 适用机型 Applicable Model |
|------------------|---------------|---------|-------------|-----------------------|--|
| | 长 Length | 宽 Width | 厚 Thickness | | |
| VC008-T1 | 1200 | 540 | 45 | 半沉式 Semi-submerged | VC008-04 |
| VC008-T2 | 1200 | 540 | 45 | 上乘式 Non-submerged | VC008-04 |
| VC008-T3 | 1200 | 540 | 45 | 半沉式 Semi-submerged | VC008-06/VPL VC008-12,13 |
| VC008-T4 | 1200 | 540 | 45 | 上乘式 Non-submerged | |
| VC008-T5 | 1200 | 540 | 45 | 半沉式 Semi-submerged | VC008-04/VWL VC008-04/VWLB VC008-04/VWLC |
| VC008-T6 | 1200 | 540 | 45 | 半沉式 Semi-submerged | VC008-12/VPQK VC008-12/VWL VC008-12/VSSM |
| VC008-T7 | 1200 | 540 | 45 | 半沉式 Semi-submerged | VC008-02/VMR |
| VC008-T8 | 1200 | 540 | 45 | 半沉式 Semi-submerged | VC008-12/VSM VC008-12/VSQ |
| VC008-T9 | 1200 | 540 | 45 | 半沉式 Semi-submerged | VC008-12/VSC |
| VC008-T10 | 1200 | 540 | 45 | 全沉式 Full-submerged | VC008-04,12 |
| HF008-T1 | 1200 | 540 | 45 | 半沉式 Semi-submerged | HF008 |
| HF008-T4 | 1200 | 540 | 45 | 半沉式 Semi-submerged | HF008/FBQ |
| Z008-T1 | 1200 | 540 | 45 | 半沉式 Semi-submerged | Z008 |
| Z008-T2 | 1200 | 540 | 45 | 上乘式 Non-submerged | Z008 |

Contact